



NEWS



TFPS News VOLUME 1-No.6 JULY/AUGUST 1996

FUN IN THE SUMMER SUN

Pedro PEZ relaxes in the Mexican sun with a mysterious lovely lady!
Look inside for more of our famous mascot's travels...plus all the latest PEZ news.

THE FLIPTOP
PEZERVATION SOCIETY
Newsletter

Volume 1, #6
JULY/AUGUST 1996
Published by Dennis Martin

INSIDE
STUFF



Well, the first year of TFPS has come to an end...and I have to say that I have thoroughly enjoyed doing this newsletter. I want to thank each of you for helping me and supporting the newsletter. I look forward to another great year of exciting PEZ news, discoveries, and fun.

A big TFPS Thank You goes to Shawn Peterson!. He is the #1 contributor of articles, news, and photos over the last year. Shawn will receive half off his club membership for next year. Keep those photos and stories coming and YOU may win next year. Also, those of you who joined from the first issue will need to renew NOW! Check your mailing label for the date of your last issue.

All TFPS members that are coming to Cleveland...bring your TFPS membership cards to my table and you will be entered into a special drawing for members only. I'll see you there.

INSIDE THIS ISSUE...

- 2 -Letters & Stuff
- 3-Richard Geary's Opinion
- 4-Seinfeld's PEZ Collection
- 6-The Search For Santa
- 8-Regional PEZ Newz
- 9-New Collectors Column
- 10-California Review
- 12-July Stuff
- 13-August Stuff
- 14-Stuck on PEZ
- 16-PEZ World Tour Continues
- 18-He's The "Cool PEZ Man"
- 19-Classified



Dear Dennis,

Please renew my membership in TFPS. And I must tell you , Dennis, you've done one heck of a job! I just love the newsletter and always look forward to the next issue. One of my favorite things is the calendar pages...I turn there first to see what you have come up with for the next two months, then I copy the pages and hang them by my desk at work. I also enjoy seeing the pics of fellow PEZheads' collections. They are just great! Another great section I enjoy is the Regional PEZ Newz which tells about the different PEZ found around the country and new items coming out.

I can hardly wait for the Bubble Man to come out. Since I laid eyes on it at the Cleveland convention, I've wanted it but couldn't pay the big bucks for it...and now I'm glad I didn't! Also, the new Smurfs you mentioned, will they be released here too or only in Europe and Canada? And I can hardly wait to see the Pink Panther and a re-release of Astrerix, Obelix, & Muselix. Why do they plan these only for Europe... why not the U.S. too? Is it because they think the U.S. cannot relate to the characters? Don't they know that half the population of the world collects PEZ and they need to spread it all over the world so us PEZheads can get our needed PEZ fix?!

Well, I don't want to get carried away, but wondered if you knew the real reasoning behind keeping them in Europe and/or Canada? Keep up the good work. Sharon Davis Olmsted Falls, OH

Sharon,

Gee, thanks for the kind words. (Your gratuitous PR check is in the mail) It's a good thing you stopped before you got carried away! All I have to say is if half the population of the world collects PEZ, it's gonna take me forever to stuff all those envelopes! The PEZ company tells me that they don't have plans to release the new stuff you mentioned in the U.S. Some of the characters aren't hot here now, and li-

censing does play a part in the decision. Also, they are busy with many projects of their own that are currently in the works. But they say that anything PEZ related that's released abroad could make it's way here someday. (See Richard Geary's article on the next page)

Dear Dennis,

I became a collector on a whim. I was in a bookstore and found a flyer for books on collectible items. When I saw the ad for Richard Geary's book on PEZ collectibles I thought it was a joke to be honest. I thought, "I've got to have this book". So I ordered it, and the rest is history. I went to the big Atlantique show in Atlantic City, NJ and scoured the booths for PEZ. I came across a PEZ gun and I thought I had found a goldmine. The booth belonged to The Gigantor Co. Inc from Glenolden, PA. I was told the gun was in perfect working condition and was given a personal guarantee by the salesman. He didn't have any PEZ candy for me to test it out, and like an idiot, I trusted him.

Of course, when I got the gun home, I found out it didn't work. I called the guy and explained that the gun didn't work. I told him I never would have paid the price I paid if I had known that the gun didn't operate and requested that he refund some of my money. He refused. He told me he would refund all of my money if I sent the gun back. He was really rude about the whole affair.

I decided to keep the gun because he obviously couldn't be trusted. Please let this be a warning to everyone. I don't consider myself to be naive. (I think) this person is up to no good. We do not need these kind of people ruining our fun of collecting PEZ. Dena Nelson Lenard New York, NY

P.S. In terms of value, am I better off leaving it alone, or should I attempt to fix it?

Dear Dena,

I'm sure you realize by now the basic rule in buying any collect-

ible is buyer beware. If it was me, I would personally want to fix it. It's not worth a lot on the resale market if it's broken or has been altered. But if you fix it and at least you can enjoy it. (See page 4 for a little help)

Dear Dennis,

I have the first set of eight body parts from 1995, and have seen three or four of the new body parts series, which are overpriced I might mention. Can you tell me where to get the new body parts? Are they available in the U.S.? Is there any truth to the rumor that the new dark-blue Batman is in danger of being recalled because the ears are too sharply pointed, and therefore a hazard to young children? I saw a Charlie Brown with his eyes closed and a Snoopy with eyes open in a friend's collection, but have not been able to find them in the stores. Are they available in the U.S., perhaps on the east coast?

Bertha Hubbard Lynden, WA

Dear Bertha,

The Body Parts are not available in the US. I believe PEZ has stopped making Snoopy with eyes open, but they aren't too hard to find in the PEZ aftermarket. Charlie Brown with eyes closed was a foreign issue. The rumor about the new Batman is running rampant in the hobby. I find it hard to believe PEZ would spend tons of money on a mold and not consider safety. One obvious sign that PEZ is concerned about safety...all recent dispensers have small parts glued on extremely tight. I think Batman is here to stay...ears and all.

Dear Dennis,

I may not be the biggest PEZ fan in the world because I probably don't have half as many as the big time collectors out there. However, when I found an old (no feet) Tweety PEZ a few years ago, old memories came flooding back of the other ones I used to have, but disappeared somehow along the way. Ever since, I make it my business to buy any character I don't already have when I walk into a "PEZ selling" store. I don't know why, I just do.

Wendy Canino Yonkers, NY

Wendy,

In this hobby, that flood of fond memories is generally followed by a drought in your wallet.

Richard's Opinion

by Richard Geary

If I were to name the most frequently asked question I receive about PEZ collecting from new collectors, it would have to be, "Where do I find older dispensers?" It's true the old dispensers are very desirable, but if you're just getting started, you can buy 50 or 60 current PEZ for very little money. Although some current dispensers are difficult to find (i.e. Hulk, Peter Pez, Regulars, etc.), it is still the thrill of looking for and finding those tough to locate PEZ dispensers that make this hobby so exciting. And if you want all the current release dispensers, you'll want to buy the one available in other countries. But, the problem is trying to figure out what new release dispensers are going to appear in the U.S., and what dispensers are not. This is where you need to educate yourself before you start to invest in PEZ.

I would like to provide a few examples of past European PEZ to give you some insight into how to collect dispensers without getting burned. Many dealers will sell a foreign PEZ for an inflated price and say they are not going to be available in the States. How can a dealer give you any correct information about a product when they do not even work for the company? Doesn't it seem a little strange that they have some kind of magical power to predict the future of PEZ dispensers

when, in fact, they have no clue? I think the reason is simple. They are fortunate enough to latch on to dispensers before they reach the U.S. market, and are usually out to make a buck. Anyway, unless it is a foreign character (ie: Mueslix), you should be **EXTREMELY CAREFUL** of what you pay. Regulars, Dinosaurs, Speedy Gonzales, Black Batman and now Bubble Man all first appeared overseas, and many collectors paid inflated prices for dispensers that can now be bought at your local K-mart for \$1.00. Several collectors paid over \$1,000 each for Bubble Man. Does that sound economical? Trust me when I say, advanced collectors and even dealers have no clue what is in the future for PEZ dispensers. My advice is, if it is currently made, it could very well come here to America. (That seems to be a building trend at PEZ Candy lately) Another idea might be to find other collectors who make trips to Europe and buy or trade with them. After all, their heart is in the right place. Or better yet, **BE PATIENT...** that new character may be in your local store soon.

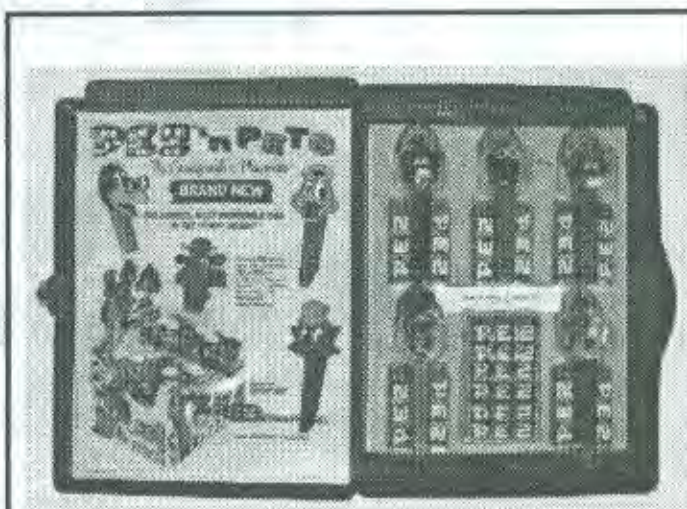

1972 PEZ Salesman
Sample Case
(Courtesy Larry Silvera)

Membership in The FlipTop PEZervation Society is \$18.00 per year. (\$20.00 Canada, \$28.00 overseas) Members receive 6 issues of the official club newsletter, a membership certificate & card, and eligibility for future special events and collectibles. Individual newsletter back issues are available for \$4.00 each. Advertising rates are as follows, classified...free, 1/4 page...\$10.00, 1/2 page...\$20.00, full page...\$30.00. And as always, if you buy 5 ads, the 6th one of equal or less value is free. Advertising space is available on a first come first serve basis. TFPS reserves the right to refuse any advertising. To subscribe, place an ad, or for more information contact DENNIS MARTIN/TFPS 2328 Farley Place Birmingham, AL 35226. Phone (205) 822-8745. The FlipTop PEZervation Society is not associated with or sponsored by PEZ Candy inc. PEZ is a registered trademark of PEZ Candy Inc.

ROBOT GUN
PATENT DIAGRAM

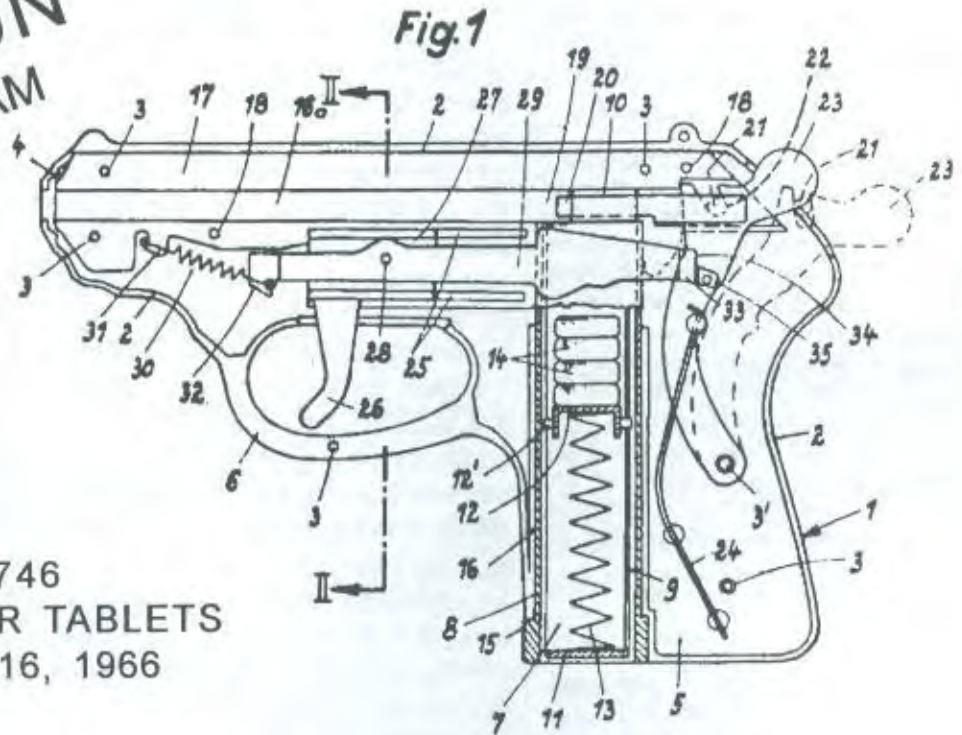

#3,370,746
DISPENSER FOR TABLETS
Filed August 16, 1966



**NEW BODY PARTS
NOW AVAILABLE!**

Order Today
\$3.50
only **each**

(no wholesale deals
on new body parts)

**ROBOT • CONVICT • CAVALRY OFFICER
CAVEMAN • LEGIONAIRE • COWGIRL**

R. BARR

P.O. Box 959, Highway 5, RR #2
Dundas, Ontario, Canada L9H 5E2 (905) 628-4047

SUBSCRIBERS TO THE PLASTIC CANDY DISPENSER NEWSLETTER

Please add \$6.00 Shipping and Handling for each order — all prices in USA funds
Money Orders and Cheques Accepted — Cheques must clear before shipping

The Original... The Biggest

PEZ-A-MANIA 6 Collectors Convention

July 19 & 20, 1996 Cleveland, Ohio

Join convention organizer Jill Cohen and hundreds of fellow collectors for an informative and fun-filled weekend. Meet master Pez collectors and all major PEZ dealers. Add to your collection. Learn from the experts. See more PEZ than you ever imagined!

CONVENTION AGENDA

FRIDAY-Pick up registration souvenir bags and informal room hopping throughout the day.
6 pm Pizza & Pasta party (reserve in advance) 7 pm Bingo for PEZ!

SATURDAY-8 am Convention open for dealer set-up. 9 am Convention registrants admitted.
10 am Convention open to general public (\$5 admission, \$2 kids under 12)
1:30 pm Convention closed. 2:30 pm Auction begins. (convention registrants only)

HOTEL RESERVATIONS 1-800-334-3741

The Cleveland Airport Marriot is convenient to the Ohio Turnpike and major expressways. Free transportation from the airport. Be sure to mention PEZ-A-MANIA to receive a special block rate of \$72 per room. A limited number of Breakfast-for-Two packages are available at \$79 per room.

DEADLINE FOR RESERVATIONS-JUNE 18 !!!!!

Any reservation received after the deadline date will be accepted on a space or rate available basis. Book Early! Every hotel in the area sells out every weekend in the summer. Last year several registrants were not able to find rooms in the area, and others had to pay a much higher rate.

-----Convention Registration-----

Please register _____ people at \$20 per person. (\$25 after June 18)

NAME STREET ADDRESS CITY STATE PHONE (include area code)

NAME STREET ADDRESS CITY STATE PHONE (include area code)

IF YOU WOULD LIKE TO REGISTER MORE PEOPLE PLEASE USE THE BACK. Confirmation letters will be sent for all registrants except for those received the last week prior to the convention.

Please register _____ people at \$10 per person (\$5 kids) for Friday night pizza party)

Souvenir T-shirts _____ \$12 each. Indicate sizes ___S___M___L___XL___XXL

Souvenir Sweatshirts _____ \$23 each. ___S___M___L___XL___XXL

T-shirt & Sweatshirt are not included with registration and will be more expensive at the convention.

Please reserve _____ dealers tables at \$25 each. (\$30 after June 18) _____ Half tables at \$15

Dealer tables are only available to convention registrants.

Please make check payable to Jill Cohen & send registration to PEZ-A-MANIA, P.O. Box 18139, Cleveland Heights, OH 44118-0139. If you have any questions or require more information, please send a self addressed stamped envelope.

PEZ is a registered trademark of PEZ Candy Company. This convention is not affiliated with the PEZ Candy Company.

THE SEARCH FOR SANTA

by Ralph Vigoda.....Philadelphia Inquirer

(Philadelphia June 5) Peter Meltzer could hardly contain his excitement when he learned that Santa Claus was in town. He just hoped he could steer him right to his Wynnewood, Pa. home, near Philadelphia. "It's a full-bodied Santa," he said.

Full bodied and very short: 4 to 5 inches tall. Made out of plastic. And with a special feature. Put your thumb on Santa's nose and push his head back, and out pops a small, bricked shaped candy called PEZ.

This Santa, of course, is a PEZ dispenser, and Meltzer wants it. That's because ...in another clear sign that the world is going nuts... PEZ dispensers are a hot collector item. How hot? In March, a PEZ convention in California drew 700 people. There will be another PEZ convention in St. Louis next week, and a third in Cleveland in July, "Seven hundred people are coming," said Jill Cohen, a Cleveland candy store owner who is running PEZ-A-MANIA there. "Last year we had people from 25 states and Canada. This year I've already got a guy coming from Slovenia."

There are at least two PEZ newsletters and dozens of Internet addresses, including one for frequently asked questions, and one put together by somebody who has written "The Dark Side of PEZ", which explores such supposed sinister facts as the number of teeth...18, or triple 6, in the skull dispenser.

David Welch, author of two books on collecting all things PEZ and perhaps the country's foremost Pezophile, recently sold a rare elephant-head dispenser for \$3,500. "It's actually a fairly ugly dispenser," said Welch, who runs a collectibles business out of his Murphysboro, Illinois home. "But there are only five known to exist. I've had four of them." He figures he's spent \$300,000 on PEZ dispensers and other items over the last five years. Right now he has about 100 dispensers in his own collection, and between 3,000 and 5,000 for sale in his inventory.

Meltzer, 37, is not "that" fanati-

cal. He has gathered about 90 dispensers since becoming interested a couple of years ago. Some are from over seas. One package is printed in Hungarian, and some are still wrapped. His most valuable is a 1950's era spaceman worth about \$150.

"I didn't have any from when I was a child," said Meltzer, who grew up in the 1960's, when a PEZ dispenser and two packs of candy went for about a quarter. "I didn't collect them when I was younger, but I used to eat them." "A friend had a collection of about 20," Meltzer said, "and looking at it one day two years ago made me realize how many dispensers there are."

Intrigued, he bought the ones on the market. Since then, his collection has grown by one or two at a time. He's found some in flea markets and gotten others through classified ads. It was through his last ad that a woman called offering the Santa and a Frankenstein's monster. Meltzer has had a couple of conversations with the owner, but they have not yet struck a deal.

His other dispensers have been lined up on the window sills of his breakfast room. Thor and Batgirl and a clown stand next to a cow and a horse and dispensers shaped like trucks. The newer ones have feet, the older ones don't. One of Meltzer's recent additions is a long-eared Batman.

I didn't realize how large this was on a national scale until I started collecting," he said. The collecting part is very much a '90's phenomenon. The first PEZ convention in Cleveland, called Dispens-o-rama, drew about 40 people in 1990, Cohen said. Attendees were drawn together through a column that appeared in a collectibles magazine. The Internet, though, has carried it much further. A PEZ fanatic in Wisconsin can chat online with one in California, and pretty soon PEZheads all across the country find they are soul mates. The Cohen Cleveland exhibition has grown from filling a small room

to requiring a 4,000-square-foot ballroom featuring 30 dealers, PEZ bingo, and an auction.

"It's easy to start collecting because 50 or 60 are on the market at any given time," Cohen said. "And it's not that expensive. Most of the popular dispensers are less than a hundred bucks." Welch said that there are between 700 and 1,000 variations of the dispensers, and that Mickey Mouse and Santa were the most popular on the retail level. But the one everybody wants, he said, is called the Psychedelic Eye...a model from the 1960's featuring a hand holding an eyeball. Price guides put it's worth between \$250 and \$350.

"There's a lot of emotional electricity attached to these things," Welch said. "There's a lot of memories. Plus the fact that they're cute. One of the reasons it's so big is because it's one of the few things men, women, and children can all collect enthusiastically."

Serious collectors know there are a lot more PEZ items than just dispensers. There are watches, bracelets, keychains, a yo-yo, inflatable rafts. Many items from Europe are not sold here, opening a market for importers of PEZ items. The PEZ universe is huge in terms of what to collect," said Welch. Still, he said, PEZ is something of a latecomer to the collectibles world. "PEZ was always marketed as a food product, not a toy." Welch said. "The people who handled it were candy distributors. So it was sold as one thing and collected as another."

PEZ was never meant to be known for it's dispensers, or to be popular with children. It was invented by Austrian candy executive Eduard Haas in 1927 as a breath mint and came only in peppermint. The word "PEZ", in fact, comes from the first, sixth, and 11th letters of the German word for peppermint, "pfefferminz". Welch said dispensers, shaped like cigarette lighters, were introduced in Europe in 1948. The company expanded to America five years later. The first heads appeared in 1955. "There were two," he said. "I haven't established which came first. One was a full bodied Santa Claus, the other a

(Continued on page 9)

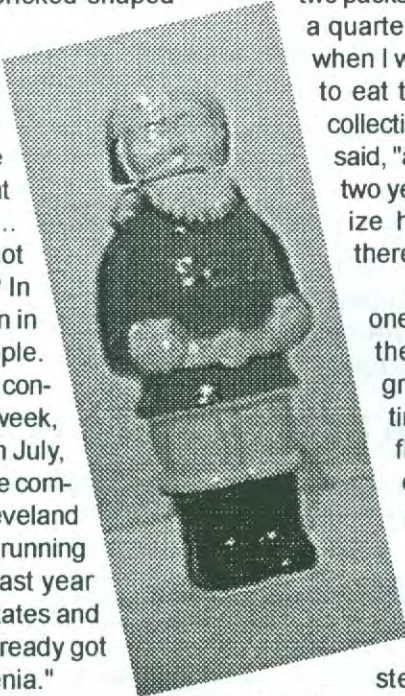

(all items no feet unless specified)

Ambassador Hallmark puzzle card...\$8
 Angel-w/f...\$35
 Baloo-w/f...\$15
 Barney Bear-w/f...\$15
 Baseball Glove & Ball...\$175
 Batman-old blue, w/f...\$10
 Body Parts-8 different...\$5 each
 Bouncer Beagle...\$6
 Bugs Bunny-old ivory face, dark gray ears w/f...\$25
 Camel Whistle-w/f...\$45
 Candy Shooter-black w/brown grips, + orig. paperwork...\$175
 Candy Shooter-orange...\$55
 Captain Hook...\$35
 Charlie Brown-eyes closed w/f...\$75
 Charlie Brown-frown, w/f...\$6
 Chick in Egg-blue egg, n/f...\$25
 Chick in Egg-purple egg, n/f...\$25
 Clown w/Chin-yellow hat...\$40
 Clown w/ collar...\$55
 Coach Whistles-w/f, 8 variations...\$2 ea
 Cool Cat...\$45
 Daffy-old, plastic eyes, w/f...\$25
 Daffy-new, on Warner card...\$3
 Dalmation Pup...\$35
 Daniel Boone...\$145
 Dog Whistle-w/f...\$20
 Dog Whistle-n/f...\$25
 Donald Duck A-MIP w/Golden Glow insert...\$20
 Donald Duck Diecut...\$120
 Droopy Dog-movable ears, w/f...\$20
 Droopy Dog-movable ears, w/f MIP...\$25
 Duck Nephew-red hat...\$6
 Duck Nephew-green hat...\$6
 Duck Nephew-old,(blue or green hat) w/light blue behind eyes...\$25ea
 Dumbo-blue w/f...\$15
 Dumbo-light blue n/f...\$55
 Easter Bunny A...\$275
 Easter Bunny Diorama...\$25
 Engineer...\$100
 Fireman-partial cheeks in yellow vending box...\$45
 Frog Whistle-w/f...\$20
 Goofy-removable teeth & nose, DBP 818.829 stem n/f...\$35
 Goofy B-n/f...\$15
 Hulk-light green-MIP w/f...\$5
 Hulk-light green-mint on American card...\$6
 Icy Bear-white stem, w/f...\$7
 Icy Bear-MOC, w/f...\$10
 Icy Bear-Mint on Winterscene card...\$25
 Indian Chief-white feathers/yellow & blue tip...\$75
 Indian Whistle-MIP, lt. tan face, yellow stem w/f...\$25
 Jerry-painted face, MOC w/f...\$7
 Jerry-3 piece w/f...\$20
 KABAYAS-Japanese superheros, 4 styles MIB...\$5 ea
 Koala Whistle-w/f...\$20



Lamb Whistle-white, w/f...\$20
 Lamb Whistle-ivory, w/f...\$25
 L'il Bad Wolf-w/f...\$15
 Maharajah...\$35
 Merlin Mouse-w/f...\$20
 Merry Music Makers-(whistles)-Panda, Rhino, Parrot, Penguin, Tiger, Donkey & Clown...\$5 ea. (Indian...\$10)
 Mickey Mouse A-removable nose-n/f...\$8
 Mimic Monkey-orange,blue,yellow face, n/f...\$30
 Mr. Ugly-dark green, w/f...\$20
 Monkey Sailor...\$30
 Monkey Sailor-orange face w/pin...\$45
 Monkey Whistle-w/f...\$15
 Mowgli-w/f...\$15
 1980's Space Gun-orange...\$65
 One-Eyed Monster-brown head...\$65
 One-Eyed Monster-orange head...\$65
 Original PEZ Make-A-Face black shoes...\$1.15 ea.
 Panda A-removable eyes...\$20
 Panda Whistle-old, removable eyes, red stem, MIP...\$25
 Peter PEZ-original...\$60
 Petunia Pig-w/f...\$15
 PEZ Masks-Dog, Pirate, Hobo or Caveman...\$50 ea.
 PEZ Truck #2-(metal 1:32 scale)...\$40
 Pirate...\$35
 Pluto A-n/f...\$15
 Policeman...\$20
 Police Whistles-8 variations w/f...\$2 ea.
 Pony-caramel w/red bridle...\$95
 Popeye A-cream face...\$135
 Practical Pig A-n/f...\$25
 Practical Pig A-w/f...\$20
 Practical Pig B-n/f...\$40
 Practical Pig B-w/f...\$35
 Pumpkin A-dark orange face/lt. orange shell, w/f...\$20
 Rabbit-fat ears (yellow or pink)...\$15
 Raven-blue head/orange beak...\$45
 Regular-green w/green cap...\$200
 Regular-pink w/white cap...\$135
 Regular-yellow w/green cap...\$135
 Regulars-new MOC (6 colors)...\$3 ea.
 Road Runner...\$6
 Road Runner-old, painted eyes/unpainted tongue, w/f...\$20
 Robot-(full body)-light blue...\$350
 Robot-(full body)-red...\$350
 Rooster-white w/f...\$30
 Rooster-yellow w/f...\$30
 Rooster Whistle-w/f...\$20
 Sailor...\$115
 Santa A-cream face...\$135
 Santa C-n/f...\$10

Santa Diorama...\$25
 Scarewolf...\$115
 Scrooge A-old w/movable hair, w/f...\$25
 Scrooge...\$6
 Sheik-red band...\$35
 Silver Glow-MOC...\$20
 Skull A-n/f...\$10
 Smurf...\$7
 Smurf-MIP,blue,white,red stem w/f...\$10
 Smurf-Papa w/f...\$7
 Smurfette-w/f...\$7
 Snowman A-black or white stem...\$15
 Speedy Gonzalez-old. olive green face, w/f...\$25
 Spiderman-removable eyes, MIP n/f...\$15
 Spook...\$110
 Stewardess...\$135
 Thumper-w/f...\$25
 Tom-painted face, MOC...\$7
 Tom-3 piece, MOC...\$10
 Tuffy-3 piece, MOC...\$10
 Tuffy-painted face, MOC...\$7
 Tweety-old plastic eyes, w/f...\$2
 Tyke B-MOC w/f...\$15
 Valentine Boy-Orig. PEZ PAL head, blue stem, n/f...\$25
 Valentine Girl-Orig. PEZ Pal head, orange or red stem, n/f...\$25
 Webby...\$6
 Wile E. Coyote...\$30
 Wonder Woman-soft head (floppy head) slight wear...\$75
 Wonder Woman-w/raised star MIB, w/f...\$15
 Woodstock-w/feathers...\$6
 Yappy Dog-orange or green face n/f...\$40
 Zorro w/Logo...\$50

TRUCKS

B8-pink cab/green truck...\$35
 B8-orange cab/aqua stem...\$55
 B9-green cab/orange or yellow truck...\$35
 C1,2,3,4,5,16-orange w/black or green stems...\$55 ea.
 C1,2,3,4,5,16-pink w/black stems...\$10 ea.
 C1,2,3,4,5,16-white w/black stems...\$10 ea.
 R1,2,3,4-non-movable wheels-36 variations...\$2 ea.

(Please include \$5 shipping.)

Willing to buy older or discontinued PEZ or make trades. Let me know what you have. I will also sell one piece or a collection on consignment.

LINDA KOCHENBURGER
 265 Beverly Hills Rd.
 Fort Lee, NJ 07024
 (201) 947-6613 (phone/fax)

REGIONAL

PEZ NEWZ



► Here's the low down on the new Valentine dispenser. PEZ will introduce it at the candy show in Washington, DC. this month (July). The new dispenser is a heart with a banner that reads "Happy Valentines Day". It will be available in pink



and red, with red stems. New packaging will include a card with a place to address your valentine, (i.e. "To:...From:") and a new pink color poly bag. Furthermore, the heart will be packaged only with grape and strawberry candy. The new dispenser should start appearing in January. Incidentally, the boy and girl PEZ will still be available, just not as a valentine selection.

► Dennis Martin (me) found a yellowish One-Eyed Monster PEZ at a thrift store last month for \$1.48! PEZ finds like that are pretty rare in my neck of the woods. (By the way, have you ever seen a wood's neck?)

► I was browsing through an old INQUEST magazine (mag. of collectible card games) the other day and came across a picture of a custom made werewolf PEZ. Apparently the magazine had a contest to "design your own werewolf PEZ". The winner received some original comic artwork. I called the magazine and asked why they used PEZ and they said "The PEZ had nothing to do with the contest other than a bizarre way of giving away a prize"

► American Express debuted a magazine ad last month that featured Jerry Seinfeld and some of his favorite stuff. Behind Jerry are

a row of 11 current PEZ. The ad appeared in several magazines including People, Sports Illustrated, and U.S. News & World Report.

► PEZ made a couple of recent appearances on Personal FX The Collectibles Show on the FX cable channel. On June 17 there was no dispenser, but a guest was wearing a black T-shirt with a PEZ Spaceman candy dispenser on it. Then, the next day, a man brought

on a Mickey Mouse Die-cut that he found while cleaning out a house. The appraisers thought it may have been a soft head that was never produced and appraised it at \$200 plus. But close-ups clearly showed it was your average Mickey Die-cut with the Die-cut plastic face. Now, what happened next is a clear sign that this hobby can be nuts at times. Someone called in and bought it for \$450!!! You can nearly buy 4 of them for that price! I just don't get it.

► Family Circle magazine (6/25/96) mentioned

PEZ in a small article about how people collect and hoard things from their past.

► Larry Silvera's original song "Baby All I Need Is You And My PEZ" is now available on cassette tape from the Burlingame PEZ store. The song was debuted at the West Coast PEZ convention. For more information call (415) 347-4576.

► I found a new PEZ T-shirt at the local mall this week. It has a red, white, & blue "shield" with

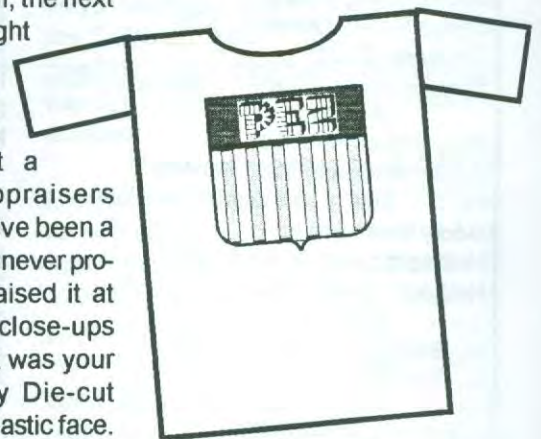

PEZ on the top. I haven't seen these before. Does anyone have anymore info on them?

► Here's a weird one... some guy on America On Line claims there's a drink that tastes exactly like PEZ. He says to mix equal parts of Southern Com-

fort and ginger ale. Try this at your own risk...and I wouldn't recommend putting it in your dispenser!

► Speaking of America On Line, several PEZheads got together last month and began a live PEZ cyberchatroom. To join in on the fun and conversation, go to the people connections area on AOL. Click on "list rooms"... then "private rooms". Then type "PEZheads"...and you're in! Most action takes place on Sunday nights at 9pm eastern.

SCOOPS...

► Be on the lookout for a **NEW DISPENSER** coming soon. The only description I could pry out of my anonymous source was that it is an elf type character with a short pointed hat with a ball on the end. I couldn't find out where and when we will see this new PEZ, but my source has seen the actual dispenser. I'll have more details ASAP.

► Also, someone has found **customized PEZ Dreamcastle jewelry at Sea World**. The jewelry is reported to have the Sea World logo and Shamu's face on them. Maybe Dreamcastle will offer more corporate sponsored dispensers in the future. Let us know if you see any.

► And then there were 4...Pezheads can't seem to get along for very long these days without gathering en masse. Just announced are plans for a **fourth PEZ convention**. The First Annual Minnesota PEZCON will be held October 11th & 12th in Bloomington, MN. The new convention will be in the Thunderbird Hotel directly across from The Mall of the Americas. The store "Simon Sez" in the mall will help host

the event (they sell PEZ dispensers and shirts), along with Andrew Thomas and Karen Cooper. For more information you can contact Andrew Thomas at 2042 Dayton Ave. St. Paul, MN 55104 (612) 646-2042. You can also e-mail Karen Cooper at kecooper@maroon.tc.umn.edu

DON'T BE LEFT OUT!

A whole new year of PEZ news starts in the next exciting issue of The Fliptop PEZervation Society. If you want to place an ad, story, photo...anything, please send it to me. The deadline for the next issue is **August 15th**. (See the address on p. 3)



Pedro enjoys a drink in Cancun

(**"Santa"** from page 6 cont.)

full-body robot."

But those full figures were too expensive, especially because the rectangular molds were already made. So company officials went to the heads-only dispensers. That's what makes Meltzer covet the Santa. It's an early one, and unusual. And it means more than candy and a toy. "Pez," he said, "was a part of life growing up." It's also become a big part of life for some grown-ups.

The **NEW** Collectors

C
O
L
U
M
N

A place for new collectors to find basic PEZ info

"PEZ Glossary"

A,B,C etc-letters after a dispenser name denote different head variations of a specific character.

Base-see stem

Blister Pack-one of the packaging PEZ are sold in. Consists of a backer card with a PEZ contained in a "blister" of plastic.

Body Parts-after market PEZ toy bodies. Plastic pieces meant to be snapped onto stem of dispenser to give the appearance of a body. Several variations sold separately by PEZ in markets other than the U.S.

Button-plastic part inside dispenser that pushes candy up to the top of the dispenser.

Clicker-metal noisemakers once offered as PEZ premiums. Each one has a silly face and PEZ logo.

Costume-cardboard insert once found in PEZ packaging consisting of a cardboard "costume" that could be flattened out and inserted over the PEZ stem to heighten PEZ play. 24 variations were available in U.S.

Die-cut-dispensers with a picture "cut" out of the side of stem.

Dream Castle-company licensed to make PEZ jewelry that actually dispensed candy. They have been bought out by Janex.

Feet-plastic tabs added to bottom of dispenser stem (in late 80's) to make dispenser easier to stand up. Tabs resemble two feet.

Full Body-refers to the two dispensers that were made with 3-dimensional bodies instead of stick bases. These are the Space Trooper robot and a variation of Santa Claus.

Header Card-attractive part of a PEZ store display with the artwork on it.

Insert-anything "inserted" into a PEZ package as a giveaway.

Can include paper comics, stickers, mail away offers etc.

Kabayas- Japanese candy containers similar to PEZ.

Kinder Eggs-Kind of a crossover between Cracker Jacks and PEZ. Chocolate egg with a plastic prize inside.

Melt-any melted plastic defect or mark on the dispenser.

MOC-Mint On Card; item is in Mint condition on original card.

MIB-Mint In Bag; item is in Mint condition in original bag.

NM-Near Mint; item isn't brand new but is in near new condition.

n/f-No Feet.

Pin-earliest PEZ dispensers had a metal pin to hold on the head instead of current plastic tabs.

Premium-anything offered as a giveaway, usually as a mail-in offer. Can include dispensers, stands, T-shirts etc.

Remake-a new version of an old dispenser from a new mold.

SASE-Self Addressed Stamped Envelope.

Stem-the stick part of the dispenser where the candy is stored.

Totems-Another PEZ copycat candy container. Dispensed round disk candy like Smarties. Several heads resembled PEZ.

TV Pals-1970's PEZ "knockoff" candy containers with character heads. Made by Lions Novelties Inc.

w/f-With Feet. Means dispenser has plastic tabs on bottom of base to aid in standing up your PEZ.

GRAB HOLD OF YOUR PEZ® BECAUSE HERE WE GROW AGAIN!

By Larry Silveira

Everyone remembers the TV series "Mission Impossible." Mr. Phelps would reach under a toilet or some other weird place, pull out a small tape recorder, and listen to a message for another insurmountable assignment. When Michael Berta and I accepted the baton of responsibility from Steve Glew after the First Annual West Coast PEZ® Convention, we weren't sure what we were getting ourselves into. We had based our business plan for The Second Annual West Coast PEZ® Convention on 100% growth. Both of us were nervous that our expenses for the convention would only delight our credit card companies. I was further dismayed when I received a phone call from a newspaper reporter in Texas. He was looking for proof for his hypothesis that PEZ® collecting was on it's way out. Boy, I wish I had written his number down because I would be giving him a call right now and say, "YOU'RE WRONG DUDE!"

The Second Annual West Coast PEZ® Convention did not grow 100% as we had hoped...It grew a whopping 325% making it the largest attended convention in the nation. In total, 702 people from around the country (including 16 states, Canada, and Austria) delighted in all of the festivities of the convention. It was held March 29th and 30th at the Sunnyvale Hilton Hotel in Sunnyvale, California (just a spit away from San Jose, CA). It was as if God had said, "Let there be PEZ® and warm spring weather," because it turned out to be a beautiful day in the high 70's. Moreover, PEZ® has become such a growing collectible that the news media devoured the convention as one of their hot weekend scoops (the terrorists must have been on vacation). The Associated Press covered the convention with reports in several papers around the country as well as ABC and CNN on national TV. But enough facts, let me tell you about the fun stuff that occurred. On Friday night the hall was filled over capacity with people seated at round tables eager to

learn and play. Gary and Nancy Doss were introduced and explained the participation of registrants who joined in most of the convention activities via the Internet. Some of you have probably heard of Gary and Nancy Doss and their Burlingame Museum of PEZ® Memorabilia. They savor PEZ® like the rest of us and exhibit it at their computer store. They set up a "chat room" for participants who were permanently attached to their computer screens from as far away as Maryland. This was no easy job and took the cooperation of many people. (And we give them a big smiling thank you.) *We believe we were the first non-technical convention to utilize the Internet this way.* In addition, 27 inch monitors at each side of the stage permitted attendants to interface with NETHEADS. In case you don't know it, PEZ® on



the NET is hot. Here's a question. If we call ourselves PEZHEADS what would PEZ® collectors on the Web like to call themselves?

The 18 vendors introduced themselves including a cute 11-year-old girl by the name of Jade who sold PEZ® for her college fund and turned out to be ... my daughter. Finally we were able to pull Johann Patek away from the TV news media as our featured speaker. Let me tell you about Mr. Patek. Johann and his beautiful wife Claudia flew to this convention from Vienna, Austria. During their 10 day visit my wife, Cheri, daughter, Jade, and I were fortunate enough to have them stay with us part of the time. Guess what? Not only does he know a lot about PEZ® and the Haas Candy Company;

not only is he a dealer of great PEZ®; not only does he and his wife speak English fluently (which is good since I only speak 3 words in German and one I say after you sneeze); but he's a wonderfully kind and humorous man. His lecture about his personal experiences around PEZ® touched all of us. He also was the first to reveal the new dispensers coming out soon in Europe which included four characters from the Pink Panther cartoon (Pink Panther, Inspector Clouseau, Ant Eater, and Termite). A question/answer period followed which helped satisfy the curios.

But now school was out and it was time to play *BINGO FOR PEZ®*. However who would be able to display all the fabulous BINGO prizes? Suddenly and from the back of the spacious room appeared...the PEZ® LADY! It was as if she had snuck out of David Welch's new book and paid us a miraculous visit. Knowing instinctively what to do, she grabbed the first prize for Bingo and displayed it for all. The Catholic church would have been proud of us as we played 30 rounds for incredible prizes like; a complete set of Merry Music Makers, a complete set of Warner Brothers characters, the Indian Brave, an acrylic display case for the three different guns with candy shooter and 80's space gun included, and a very special secret prize. Participants were shown a box and told the following, "It is a real PEZ® dispenser and there are only ten dispensers like this in the world. There are only four displayed like this in the world which we believe triples its value: this one for Bingo, one purchased by Michael, one purchased by Larry, and we will sell one in the auction. All the money from this round and the sale of these dispensers will be donated to the Susan G. Komen Breast Cancer Foundation." Money rustled like the sound of Fan Dancers, and after all the cards were purchased I asked if they wanted to see what they were trying to win. But they all voted, "No!" They wanted the winner to open the mystery prize. Well the winner walked up to claim her prize and cautiously revealed a shadow box which contained a Wonder Woman A PEZ® Dispenser signed by Lynda Carter and an 8X10 photo of her as Wonder Woman which was signed, "Have fun

(Continued on page 15)

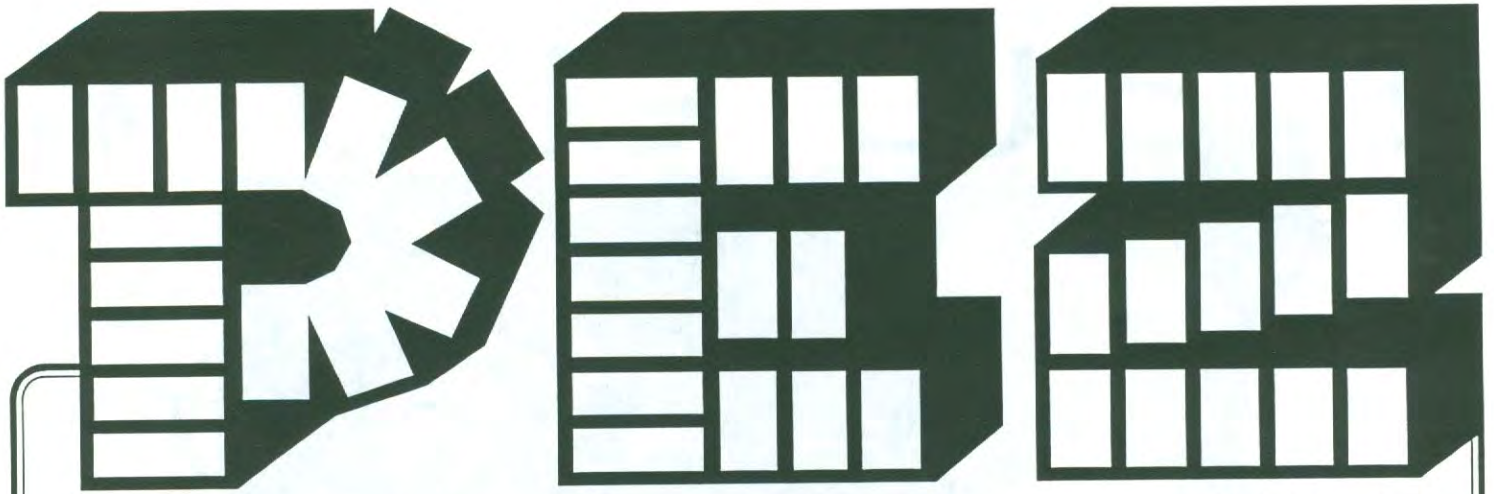

SUPER SELECTION for SALE

WARNER BROS

Only \$3.00 each

Speedy Gonzales

Road Runner

Sylvester with Whiskers

M.G.M.

Only \$3.00 each

Tom • Jerry
Spike
Droopy Dog

PEANUTS

Only \$3.00 each
Woodstock/Feathers
Charlie - Tongue
Charlie - Frown

WALT DISNEY

Only \$3.00 each

Scrooge McDuck

Duck Nephews

Bouncer Beagle

Gyro
Gearloose

Webby

MERRY MUSIC MAKERS

Only \$3.00 each

Parrot

Clown

Penguin

Tiger • Panda

Rhino • Donkey

SPECIAL ITEMS

Icee Bear only \$3.50 each

Only \$7.00 each:

Painted Tom • Painted Jerry
Painted Tuffy

PEZ PARTS

8 Different - \$3.50 each

Hockey Player • Nurse

Tarzan • Maid • Grim Reaper

Red Dress • Robin Hood

Knight

★ NEW BODY PARTS ★

Only \$3.50 each

Convict • Legionaire

Cowgirl • Caveman

Robot • Cavalry Officer

----- All Above Pez in Regular Stock -----

Wholesaler Enquiries Welcome – Call Today for Information

All our (MOC) Pez are on European cards with 3 packs of European Pez
Please call for availability — Many of each now in stock — Unopened cases of 36 available

R. BARR P.O. Box 959, Highway 5, RR #2
Dundas, Ontario, Canada L9H 5E2 (905) 628-4047



SUBSCRIBERS TO THE FLIPTOP PEZERVATION SOCIETY NEWSLETTER

Please add \$6.00 Shipping and Handling for each order — all prices in USA funds
Money Orders and Cheques Accepted — Cheques must clear before shipping

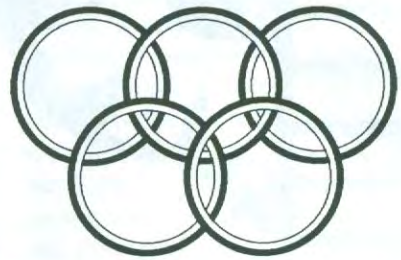
J U L Y



"VUCHKO WOLF" Olympic PEZ

SUN	MON	TUE	WED	THU	FRI	SAT
	1	2	3	4 	5	6
7	8	9	10	11	12	13
14	15	16	17	18	19  Olympics Open	20
21	22	23	24	25	26	27
28	29	30	31			

JULY

TOY SHOWS, ANTIQUE SHOWS, FLEA MARKETS

- 7-Old Toy Show-Leesport, PA
Farmers Mrkt. Social Hall
610-562-5559
- 13-Collectibles Expo '96
Elizabeth, NJ Holiday Inn
Jetport 201-385-1557
- 13 "Hotlanta" Toy Expo
Hilton N.W. Atlanta
770-592-2199
- 13-14 Collectible Show
Charleston, WV
Civic Center 614-878-6070
- 19-20 PEZ-A-MANIA 6
Cleveland, OH

BIRTHDAYS

- 1-Dan Akroyd (44)-actor
- 1-Cheryl Ladd (44)-angel
- 6-Merv Griffin (71)-wheeler
- 6-Burt Ward (51)-Robin
- 7-Ringo Starr (56)-Beatle
- 16-Stuart Cartwright-PEZhead
- 18-John Glenn (75)-astronaut
- 24-Lynda Carter (45)-Wonder Woman PEZ
- 31-Curt Gowdy (77) sports commentator

Anti-Boredom month...National Baked Bean month...1st-Halfway point of 1996...3rd-1st U.S. bank opened (1819)...4th-American Redneck day...4th-Great Cardboard Boat Regatta (Sheboygan, WI)...5th-Workaholic day...6th-International cherry spitting contest (Eau Claire, MI)...11th-Skylab fell to Earth (1979)...17th-Hog calling contest (Baltimore, MD)...18th-Oscar Mayer Weinermobile 60th anniversary...19th-National Zippo lighter day...26th-28th-UFO days (Elmwood, WI)

AUGUST



CLOWNING AROUND PEZ STYLE!

AUGUST

TOY SHOWS, ANTIQUE SHOWS,
FLEA MARKETS

5-Kids Swap Shop-Broadway
Market

Square, Baltimore, MD
(410) 396 9177

8-National Hobo Convention-
Britt, IA (515) 843-3867

10-Toy Show-Ft. Lauderdale,
Elks Exhibition Center
305-942-9929

11-Toy Show-East Hartford, CT
Elks Club 860-589-8037

15-18 450 Mile Outdoor Sale-from
Kentucky to Alabama,
800-327-3945

BIRTHDAYS

4-Helen Thomas (76)-reporter

5-Loni Anderson (50)-blonde

8-Mel T-T-T-Tellis (64)-singer

9-Whitney Houston (33)-singer

11-Hulk Hogan (43)-wrestler

16-Madonna (38)-not a virgin

19-Bill Clinton (50)-Hillary's boy toy

22-Ray Bradbury (76)-author

24-Cal Ripkin Jr. (36)-ball player

25-Monty Hall (73)-deal maker

28-Scott Hamilton (38)-skater

29-Michael Jackson (38)-Elvis Inlaw

SUN	MON	TUE	WED	THU	FRI	SAT
				1	2	3
4	5	6	7	8	9	10
11	12	13	14	15	16	17
18	19	20	21	22	23	24
25	26	27	28	29	30	31

Foot Health month...1st-7th-International Clown Week...2nd-3rd-Bratwurst days (Sheboygan, WI)...3rd-National Mustard day...
4th-10th-National Pamper Yourself week...5th-9th-Psychic week...7th-First picture of Earth from space (1959)...9th-13th-
Perseid Meteor Shower...10th-16th-Republican National Convention (San Diego, CA)...15th-Cockroach Derby (Rutgers Univ)...
15th-Woodstock Anniv. (1969)...16th-Elvis died (1977)...17th-Watermelon day (Vining, MN)...25th-Kiss & Make Up day



by Richard Geary

Through the years PEZ has created some pretty nifty inserts to go along with the candy refills. Of late, PEZ Europe has continued this tradition with a series of stickers included in the refill packs. For the most part the stickers are from cartoon characters and come in a set of eight different stickers.

I have noticed that some dealers and collectors are still offering these stickers for sale at very reasonable prices. Consider this, the refills alone cost around a buck twenty-five, so if you add the sticker to the refills the set of eight would cost approximately \$10.00. Not too bad for an item that is only available in Europe. Not to mention this is a great "go with" item.



The series of recent stickers that I am aware of are as follows:

- FLINTSTONES
- LOONEY TUNES
- TOM & JERRY
- DINOSAUR FAMILY
- SCHOOLS OUT
- FRUIT CHARACTERS
- REAL DINOSAURS



If anyone else has knowledge of other existing stickers series, please contact Dennis Martin.

("West Coast" from page 10 cont.)

at the PEZ Con. Love, Lynda Carter." The sale of all nine of the ten dispensers (with one still for sale) netted \$603.00 which went to the above charity at the request of Ms. Carter. Another prize was a similar shadow box with a new regular dispenser signed by Bill Mummy with an autographed photo with him and the crew from the series, "Lost in Space." Bill currently portrays Linnier in the series, "Babylon 5" and has been an avid PEZ® collector since 1962! Tired yet still excited, collectors stormed through the hotel and room hopped until at least 1:30 AM.

The next morning, show time came early for the 18 vendors, 3 staff, and 47 volunteers who prepared a spectacular showroom. The hotel named this hall the Champagne Room and was it ever with its high vaulted ceilings and an entire wall of windows overlooking a man-made lake and beach. Registrants for both days were to get in at 9:30 A.M. But when I barked out the order to, "Hold em back," to complete a few last minute touches, the line which had now gone into the lobby didn't like that idea at all. Not being trained in riot control, the doors swung open and smiling PEZheads emerged.

Michael and I had wanted to make this event an entertainment extravaganza and not just another toy show. With that in mind, we only butted vendors around the perimeter of the large well lit room. This gave participants breathing space to pull away from the sometimes 5 deep crowds that gathered about the tables to anxiously buy their dream dispensers. Raffle prizes abounded. Some of the better prizes included: King Louie, Mowgli, Frog, Angel, Dog, Merlin Mouse dispensers, a PEZ® backpack, a set of 13 Merry Music Makers, and an Uncle Sam dispenser. Our gorgeous PEZ® Lady was always ready for picture requests.

Probably the best attraction was what we believe to be *the world's largest public display ever of PEZ®, PEZ related items, and non PEZ dispensers.* Thanks to Barry Koester and

Johann Patek we had some extremely rare items on display. You know the ones we can only dream of owning. On exhibit and filling six display cases were: the bride and groom, purple pony, Make-A-Face on card, the square regular (one known), the Ben Hur regular (one known), the ivory lock stem BOX regular, the one piece elephant, a transparent 50's space gun, some mock ups and trials and ugly color variations, rare ad and salesperson pieces, *and just about every other dispenser made.* A gaggle of many other non PEZ dispensers were also proudly shown. In addition, had you been there you could have heard Zep and the PEZHEADS perform their new hit entitled, "Baby all I need is you and my PEZ." (By the way Zep is PEZ spelled backwards.)

Like the last piece of a jig saw puzzle, the auction was the finale of two wonderful days. Bidding was pretty tame except for a few items, one of which was the other Wonder Woman autographed dispenser in a shadow box which went for \$170.00 to the amazement and applause of the crowd.

So there you have it. If you attended then this little report is a *deja vu*. If you couldn't make it then I hope you caught a little flavor of this wonderful happening.

Finally one more thing, Michael and I would like to publicly thank the following: the 18 vendors who took a chance with this convention and went home with smiles on their faces (not to mention a lot fewer dispensers than they came with); the 47 volunteers who without their help we would never have pulled off this event; Adrienne Vilaubi who designed, made the costume, and performed as the beautiful PEZ® Lady; Johann Patek and his wife, who I'm certain will now be on the PEZ® high demand lecture circuit; my lovely wife Cheri who worked for peanuts and put up with a lot ; and PEZ® Candy Inc. Why PEZ® Candy you might ask? After all isn't it true that we collectors at best are an annoyance to them? This is not the case. In my conversations with Bud Damberg, head of PEZ® Candy's marketing and advertising department, he stated, "We love collectors and try to help them any way we can." We found them to be supportive and cooperative of our convention. They even sent us older advertising "sells" to give out free to the first 200 registrants. From my perspective this relationship is definitely being cultivated in the right direction. Hope to see you at The Third Annual West Coast PEZ® Convention!!!





WORLD TOUR SCRAPBOOK

Dear TFPS,
 Thanks for letting Pedro go along with us on our recent vacations. Pedro went with us to The Desert Museum and Colossal Caves in Tucson. We then drove through Palm Springs to Disneyland. You should have seen Pedro's expression as he rode down the hill on Splash Mountain! Pedro's favorite ride was the Matterhorn. While at Disneyland Pedro also met with characters at breakfast, visited Disney PEZ, played in Toon Town, and watched parades. Pedro rode every ride in the park and didn't seem to be tired like the rest of us. It was hard to leave California...but it would be worth it at our next stop...the St. Louis PEZ convention! Pedro socialized with many people during room hopping Friday night. He met Steve Glew, David Welch, Maryann Kennedy, John Devlin, Jill Cohen, Brian Gochal, Mary Thronson, Mike Edelman, Nick Eschenbrenner, Michele Lorenz, and many other nice PEZheads. Pedro had a really nice time playing BINGO Friday night. Saturday Pedro went around the room like he had known everyone for years. Overall... Pedro was well behaved and had a great time. But he was ready to pack up and continue his travels. We said goodbye and put him on the road to his next destination... Austria!

Mike Miller



Maryann Kennedy



Mike Miller & Nick Eschenbrenner



Miller Family, Pluto, and Pedro

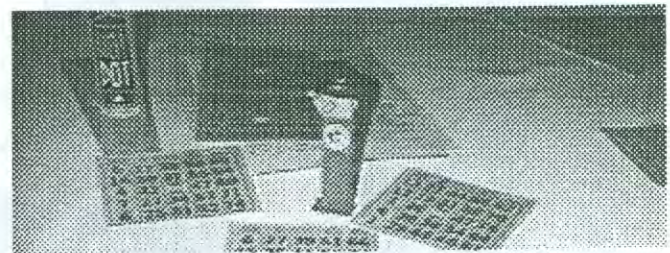

PEZ Bingo



Pedro with Jill Cohen



Pedro with Steve Glew & David Welch

SJ GLEW

5611 Lehman Rd., DeWitt, MI 48820
 Phone (517) 669-5931
 Please add \$4.00 postage



PHONE (517) 669-5931
 FAX (517) 669-3581 24 hr.

SHOE STAND FOR PEZ \$.50 EA. OR \$55.00 FOR 144 Always Buying PEZ

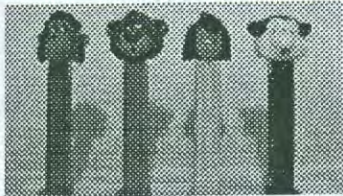

\$15 EA. Prac. Pie A
 Petunia Pie
 King Louie
 Mowli
 Lil. Wolf
 Barney Bear
 Baloo
 Dumbo

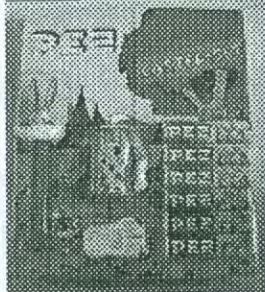

Easter Body Parts
 Playworld set..\$25



Santa Body Parts
 Playworld set..\$25

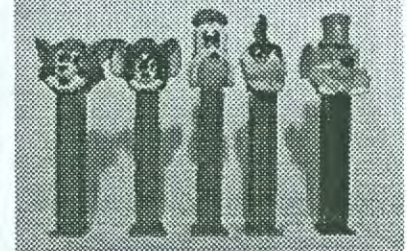

Tom, Jerry, Droopy..\$5.00 each MOC
 Roadrunner..\$10.00 each, MOC
 Merlin..\$10.00each, loose

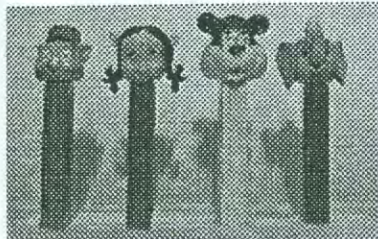

Ice Bear, Smurfette, Smurf & Papa
 Smurf, all loose.....\$5.00 ea.

C Class Trucks C-1,2,3,4,5,16

Pink cab, Black stick.....\$60. set
 Yellow cab, Black stick.....\$60. set
 Yellow cab, Red stick.....\$90. set
 Orange cab, Black stick.....\$240. set
 Orange cab, Green stick.....\$240. set

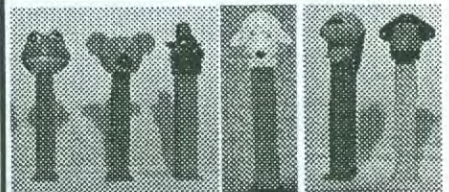

Frog or Koala music maker..\$30 ea. Camel
 music maker..\$40 ea. Lamb, Dog or
 Monkey music maker..\$25 ea.

PEZ Regulars, 6 different MOC.....\$15.00 set
 PEZ Regulars, 6 different loose.....\$12.00 set
 Silver Glow, MOC.....\$15.00 each
 Silver Glow, loose.....\$12.00 each



Incredible Hulk, new, loose 2/\$5.00
 Speedy Gonzales, new, loose 2/\$5.00
 Dark Knight, new, loose 2/\$5.00
 Yosemite Sam new, loose 2/\$5.00
 TAZ new, loose 2/\$5.00

4 New Body Parts (regional, cavalry, convict, robot)...\$25.00

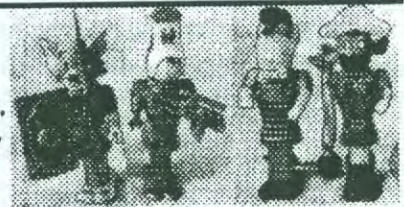

All Pez Below \$5.00 each



Donald D. 3,410,455 no feet Loose
 Mickey M. 3,410,455 no feet Loose
 Spike MOC
 Tuffy MOC
 Droopy Dog MOC
 Bouncer Beagle boy MOC
 Scrooge McDuck MOC
 Penguin Melody Maker MOC
 Donkey Melody Maker MOC
 Tiger Melody Maker MOC



Parrot Melody Maker MOC
 Clown Melody Maker MOC
 Rhino Melody Maker MOC
 Panda Melody Maker MOC

Body Parts MOC

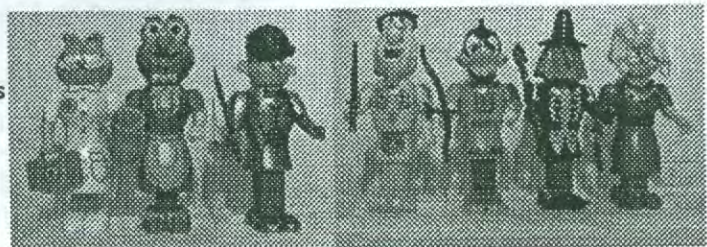

Nurse, Purple Dress, Knight, Tarzan, Robin Hood, Reaper, Red Dress
 (Dispenser not included)

He's "The Cool PEZ Man"



A bride and a pineapple—that's all John Devlin is missing. He knows where to get both, but he doesn't want to pay for them.

The bride and the pineapple in question are PEZ candy dispensers. Devlin, who lives in south St. Louis county, collects them.

Known in PEZ circles as "The Cool PEZ Man," Devlin said he has about 700 PEZ dispensers, some worth as much as \$3,000. He keeps the valuable dispensers in a safe deposit box, but some of the others are on display in his home.

Devlin, 40, started seriously collecting PEZ dispensers in 1988. His collection includes a Frankenstein dispenser, a panda, Batman, Mickey Mouse, Snoopy, Santa Claus, Popeye, Pluto, Miss Piggy, an Elephant, the Green Hornet, The Teenage Mutant Ninja Turtles, Pinocchio and Snow White.

He has 31 different bunny-head dispensers. He has a European PEZ dispenser with a little orange hippopotamus on top. He has every pony dispenser made except the one with the purple head. And he has a couple of the "psychedelic" designs, including the open flower with the eyeball in it.

Devlin even has a small collection of "rip-off" PEZ dispensers that in-

cludes Mr. Spock of Star Trek fame, the Alien and Cat in the Hat. He also boasts a healthy collection of PEZ-related artifacts, such as the PEZ Frisbee The PEZ beach umbrella, PEZ lapel pins, The PEZ skateboard and the PEZ jigsaw puzzle. A PEZ sales rack in one corner contains PEZ dispensers and candy in the original packages.

Devlin admits his collection takes up a lot of room. But not as much as his previous collections.

"I used to collect pinball machines," he said. "I never had more than 10 at one time, though." Devlin has also curbed his fancy for juke boxes and sporty cars. Devlin said that as a boy he collected shells (when he lived in California) and coins (when his family moved to St. Louis).

"I've been involved with collecting all my life," Devlin said. "I sold my stamp collection to buy my wife's wedding ring."

Devlin works as a stationary operating engineer, running boilers. He also runs conventions—PEZ conventions. Devlin organized the first PEZ collectors convention in St. Louis in June 1993. At the conventions, collectors trade and sell dispensers. Some cost as little as \$5 or less. Some cost a good bit more.

The "Make-A-Face" PEZ dispenser, which is something like a Mr. Potato Head toy, with interchangeable parts, is rare. The dispenser, in the original package with all the parts, is worth between \$1,500 and \$3,000, Devlin said.

All this excitement over a little candy—and at that Devlin can't get cherry PEZ, the flavor he likes best, in the United States. He has to go to Canada, where cherry PEZ is still available. The dispensers are manufactured in China, Hungary, the Czech Republic, Austria and Slovenia.

"If you count heads, there must be close to 300," Devlin said. "But there are variations on the heads, and nobody really knows just how many."

He said the bride PEZ dispenser that he wants is available from other collectors, but he doesn't want to pay the price—\$600. The groom can be had for a mere \$150.

As for the pineapple, Devlin actually had one once. He traded it in a two-for-one deal. Now that pineapple is worth \$1,000.

"I just can't see paying it."

St Louis Post-Dispatch
1994

PEZ COLLECTOR is interested in starting club in south Florida. (the North Dade, Broward and south Palm Beach area) Anyone interested please contact **BILL KERMIT 1313 S. Military Trail #292, Deerfield Beach, FL 33442** If there is interest, an initial meeting will be arranged.

PEZ ADVERTISING and display items wanted. Also older PEZ color variations. **MARYANN KENNEDY 409 N. 5th St. Marshall, MN 56258 (507) 532-6926**

WANTED: Buying PEZ, anything PEZ, TV Pals, Yummys, Totems, Crazy Fruits, Jay Ward & Hanna Barbera watches, Robots, Space & Battery Op toys-any condition. **STAN LUKSENBURG 21457 Lorain Rd. Fairview Park, OH 44126 (216) 356-1118**

Dust or Us! Everyone is ordering them...PEZ Display cases. Display-Organize-Protect. \$10.00 ea. plus S&H, 4 or more ONLY \$7.95 plus S&H. Visa/MC accepted. Revolutionary clear, soft plastic will protect from dust, damage, and theft. Snap on lid, shelf or wall mount, lock together when stacked. Dealerships available. Send L.S.A.S.E. to Dept. PC1 at Collectors Display Case Co. RT2 Box73 Fremont, NE 68025-9635 (402) 721-4765

PEZ, PEZ Display cases and Silly Putty for sale! PEZ selection varies from month to month. Display cases and shelves range in price from \$10-\$150. Silly Putty in bulk for sale @ \$15 a pound plus shipping. Send SASE for details. **Gene Schenberg 2631 Southern Hills Blvd.-Suite 1; Arlington, TX 76006 (817) 649-2916** fax or e-mail me directly at 70007.273@compuserve.com or visit my web page at: http://ourworld.compuserve.com/homepages/pez_stuff

BRIDE & GROOM needed for my wedding cake. Can't get married without them! **LONNIE 1838 5th Ave S. Fargo, ND 58103 (701) 237-5881.**

THE PEZ ARCHIVES

8 1/2" X 11" photocopies of the following PEZTORICAL publications available @ \$2 each. \$4 shipping additional each set of newsletters. (overseas add \$8 per set) THE OLD VARIETY STORE-June 1987 thru Nov/Dec 1989 (15 issue), THE OPTIMISTIC PESSIMIST-Jan 1990 thru July 1992 (15 issues), POSITIVELY PEZ-Jan 1993 thru Jan 1996 (19 issues) Single copies available for \$2 each plus .50 per copy postage. Send SASE for new sales list. **LINDA KOCHENBURGER 265 Beverly Hills Road Fort Lee, NJ 07024 (201) 947-6613**

PAYING TOP DOLLAR

For rare and unusual PEZ. Advertising Regulars, Bride, Arithmetic, Lion's Club, Diecuts (Casper, Easter Bunny, Bozo, Mickey, & Donald). Also premiums and any PEZ dispensers from 50's, 60's, & 70's. **RON CASPARI 214 Piermont Rd. Norwood, NJ 07648 (201) 768-3875**

WANTED!!! Anything PEZ, anything at all (willing to be sold under \$50) I have most common dispensers and a few European, including Body Parts. Please write, call or FAX. **SARAH JAYE BURPEE 46 Pearson Rd. Merrimack, NH 03054. Phone 603-471-0751 anytime, in evenings or weekends FAX 603-471-0751 anytime. Thanks!**

PEZ COLLECTOR seeking the following: Lucy w/white eyes, baseball for glove, homeplate, old lapel pins, and unusual PEZ or related items. Older MOC items and boxes needed. Send best price to **GARY OLSEN 702 Stonegate Lane Stanhope, NJ 07874**

PEZ WANTED: Looking for 60's-90's PEZ dispensers, & other PEZ merchandise.

RON GOETZ (216) 498-1040

RECENT PEZ DISPENSERS! Don't feel like hunting? I'll send you 10 different dispensers for \$20.00 That includes shipping. Send money order to: **WILLIAM DANIELS 511 Charlton St. Southbridge, MA 01550**

PEZ COLLECTOR looking for others to buy, sell, & trade. Having a hard time getting PEZ puzzle by Hallmark and greeting card from Ambassador Cards. Can anyone out there help me?

SANDRA BERNARD 563 Cabot St. Beverly, MA 01915

CANADIAN COLLECTOR

Looking for the following PEZ dispensers: Orange, Panther, Giraffe, Cow A, Cow B, Pony, Gorilla, Crocodile, Elephants, A-B-C series Trucks, (Especially R1) Casper, green Spike, Rudolph, & Santa B. Please send me your list with prices. **KEVIN SCOTT RR#1 Sebringville, ON, NOK 1XO Canada 519-393-5334 (evenings EST)**

WANTED BY PRIVATE COLLECTOR: Donkey Kong Jr w/original mailing box, Lion's Club Lion, Olympic Wolf w/ski hat, any Disney rubberhead, Bride, Box trademark, Box patent, Disposable personalized U.S. Zone, Regular locking cap, Regular super, Make-A-Face loose or carded, any Ad regular, as well as unique oddball PEZ items. Also looking for 1960's bobbing head dolls (both sport & non-sport), Pillsbury doughboy items and any original Brady Bunch items. **GREG SHOLES 9 Main St. Warwick, NY 10990 914-987-2323**

SOMEONE PLEASE HELP me complete my set of Flintstone's Kinder Egg toys. If anyone already has any of the new Warner Bros. PEZ, please contact me. I'll see you in Cleveland this summer. Anyone want to be pen-pals? Please write or call. **GENE YOUNG P.O. Box 1913 Danville, IL 61832 (217) 748-6992**

**THE
SPACE GUN**®

